



## LiteDOCK Extreme Quick Start Guide



iridium

BEAM Communications Pty Ltd

**BEAM Communications Pty Ltd**  
5/8 Anzed Court, Mulgrave  
Victoria, 3170, AUSTRALIA

Tel: +61 3 8588 4500  
Fax: +61 3 9560 9055

Info: info@beamcommunications.com  
Support: support@beamcommunications.com

www.beamcommunications.com



LiteDOCK Extreme Installation set up

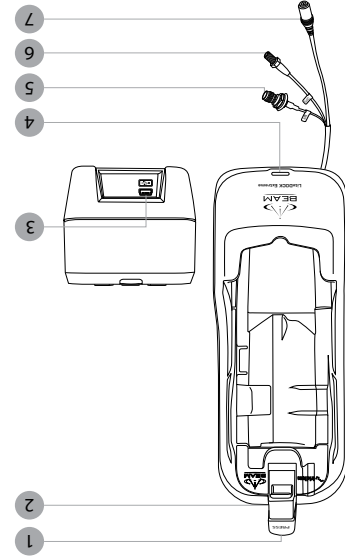

- 1 Latch button
- 2 Docking latch
- 3 Mini USB port

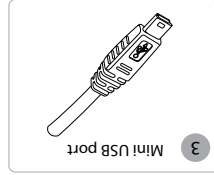

- 4 STATUS indicator
- 5 Iridium antenna connector
- 6 GPS connector
- 7 DC power jack

Powered by

- Iridium 6V AC/DC adaptor
- Iridium car cigarette lighter charger
- USB

- Purpose built cradle to hold Iridium Extreme handset
- RAM - mounting system
- Supports external active GPS antenna
- Supports external Iridium antenna
- Supports SOS & tracking (via Extreme handset)
- Charges Extreme handset

LiteDOCK Technical Specifications

POWER SPECIFICATIONS	
Rated Input	6V DC, 850mA max
AC Power Pack	Not included (adaptor included with your Iridium handset)
Average Power Consumption	5 Watts
INTERFACES	
Data Port (USB)	USB Mini-B-5-pin female (USB Slave)
Power Cable	Inline circular socket to support Iridium 3mm power jack
Iridium Antenna Connector	TNC Female
GPS Antenna Connector	Active 3.3V DC, SMA Female
KIT CONTENTS	
LiteDOCK Cradle	
Universal Mounting Bracket (RAM)	
Earpiece Extension Cable	
Quick Start Guide	

ENVIRONMENTAL

Operate Temp. Range	LiteDOCK -30°C to +70°C Extreme Handset -10°C to +55°C
Charging Temp. Range#	0°C to 45°C
Operating Humidity Range	> 85% RH non-condensing
Storage Temperature	-30°C to +80°C
Weight (Dock Only)	375g
EMC Compliance	CE
RoHS	Full compliant RoHS Directive EU 2002/95/EC (All 6 substances)
WEEE	For EU countries, this product must be collected separately from household waste, as defined in each region. This product must not be discarded together with household waste.
Flame Retardant	UL94.0
Safety - SELV	EN/AS/NZ 60950-1

## 1) Mounting Cradle

The LiteDOCK Extreme is supplied with a universal RAM® mount bracket that enables mounting to any flat surface (vertical or horizontal) within a vehicle, or other required location.

1. Attach one pivot base to the rear of the LiteDOCK Extreme using the M4 screws and washers supplied.

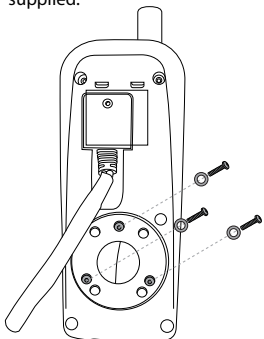

2. Secure the second pivot base to the location you have selected for mounting the LiteDOCK Extreme. (Screws not supplied)

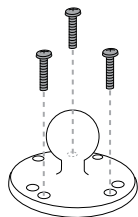

3. Use the interconnecting arm of the RAM® mount to secure the LiteDOCK Extreme to the pivot base and tighten into the desired location firmly using the wing nut on the arm.

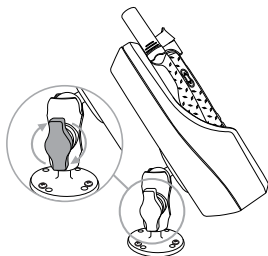

## 2) Iridium & GPS Antenna Connections

The antenna connections exit from the rear of the LiteDOCK Extreme cradle, via the antenna loom. There are two RF connections required, the Iridium TNC female connector and GPS SMA female connector.

1. Refer to the antenna installation guide for antenna mounting and location requirements.



### WARNING

*DO NOT pull with force on the cables from the rear of the LiteDOCK. Please install strain relief clamping for the antenna cables where required. Correct installation of the antenna system is a vital part of the LiteDOCK system, to ensure reliable functionality, and drop-free calls.*

## 3) Inserting and Ejecting Extreme Handset

### Inserting:

1. At the base of the Iridium Extreme handset there is an accessory connector cover. Open the cover and move it to the back of the handset, securing it to the two rear retaining features.

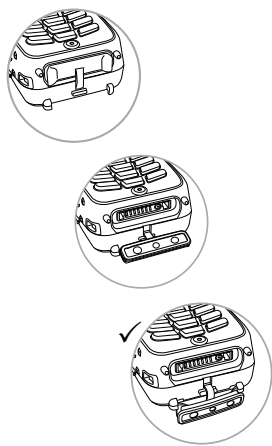

2. Press down the latch button and then gently rotate it up to open the latch. Place the Iridium Extreme handset into the LiteDOCK Extreme.

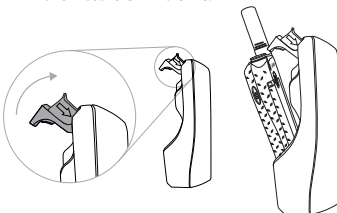

3. Lift the latch back over the handset until it Click's into place.

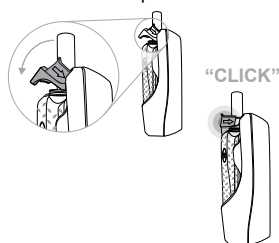

### Removing:

1. To remove the handset, first press down on the latch button and then rotate the latch up and away from the handset. The handset can now be slid up and out of the LiteDOCK. Refit the accessory connector cover to maintain the IP rating of the Iridium Extreme handset.

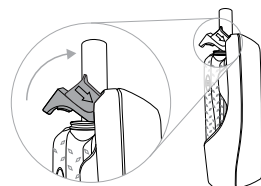
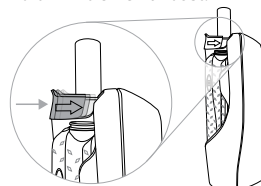

## 4) Power Connection

1. Connect a power source to the DC power jack on the cable loom, either the Iridium AC/DC adaptor, or the Iridium car cigarette lighter adaptor. Power can also be connected via USB to the USB port on the bottom of the LiteDOCK.
2. The green status LED will turn on to indicate it has power.
3. When the Iridium Extreme handset is docked it will automatically start charging.



### NOTE

*If the Iridium Extreme handset is OFF, the LiteDOCK will not automatically switch the Iridium Extreme handset ON. You will need to manually switch ON the Iridium Extreme handset.*

4. Check the Iridium signal on the handset to make sure that the antenna is connected correctly and is receiving a signal.

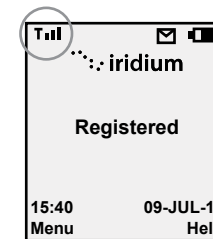

5. Press the button on the right side of the phone to check the GPS fix.

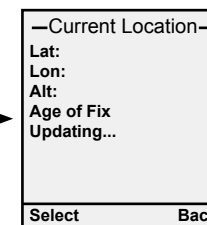
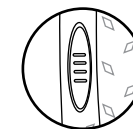

## 5) How to Make a Call

To use the LiteDOCK for a call, you will need to either:

1. Enable the Iridium Extreme handset speakerphone function after the call is connected. (Refer to the Iridium Extreme User Manual)
2. Connect the Iridium Extreme earpiece to the Extreme handset. The connection for the Iridium Extreme earpiece is on the right side and an extension cable (supplied with the LiteDOCK) will need to be plugged in before docking the handset into the LiteDOCK. This cable will allow the use of the earpiece.

